

This manual has been prepared with particular care. At any time and without prior notice, MPW MED. INSTRUMENTS can introduce improvements and changes in the manual resulting from noticing typographical errors or improving the device. All rights reserved. No part of this document may be modified, distributed, published or reproduced without the consent of MPW MED. INSTRUMENTS.

You can find the current version of the manual on our website under:









<https://mpw.pl/en/to-download/user-manuals>

Content

| | |
|---|-----------|
| 1. Symbols used in the manual and on the device | 5 |
| 2. Application | 5 |
| 3. Technical specification | 6 |
| 3.1 Environmental conditions | 6 |
| 4. Installation | 7 |
| 4.1 Content of package | 7 |
| 4.2 Location | 8 |
| 4.3 Current protection | 8 |
| 5. Safety | 8 |
| 5.1 General remarks | 8 |
| 5.2 Placing the rotor and accessories in the centrifuge | 9 |
| 5.3 Filling the rotor | 9 |
| 5.4 Filling the tubes | 10 |
| 5.5 Safety hints | 11 |
| 5.6 Operating conditions | 12 |
| 5.7 Work safety | 12 |
| 5.8 Unbalance | 13 |
| 5.9 Emergency stop | 13 |
| 5.10 Residual risk | 13 |
| 6. Operating | 13 |
| 6.1 General description | 13 |
| 6.2 Control elements | 14 |
| 6.3 Control panel | 14 |
| 6.4 Name plate | 15 |
| 6.5 Control device | 15 |
| 6.6 Entering parameters | 15 |
| 6.7 Safety features | 16 |
| 6.8 Temperature increase | 16 |
| 7. Control elements | 16 |
| 7.1 Program selection | 16 |
| 7.2 Default settings | 16 |
| 7.3 Unit selection - RPM / RCF | 16 |
| 7.4 Editing the program | 17 |
| 7.4.1 Spin speed adjustment (RPM) | 17 |
| 7.4.2 Relative centrifugal force adjustment (RCF) | 18 |
| 7.4.3 Spin time adjustment | 18 |
| 7.5 Advanced program parameters | 18 |
| 7.6 Service menu | 19 |
| 8. Centrifuging | 21 |
| 8.1 Centrifuging with set time | 21 |
| 8.1.1 Start centrifuging | 21 |
| 8.1.2 Braking | 22 |
| 8.1.3 Stop centrifuging | 23 |
| 8.2 SHORT mode | 23 |
| 8.3 Continuous spin mode (HOLD mode) | 23 |
| 8.4 Cancel the centrifugation | 24 |
| 8.5 Changing parameters during centrifuging | 24 |
| 9. Service life, maintenance and chemical resistance | 25 |
| 9.1 Service life of equipment | 25 |
| 9.2 Maintenance of the centrifuge | 26 |

| | | |
|------------|--|-----------|
| 9.3 | Maintenance of equipment..... | 26 |
| 9.4 | Sterilization..... | 27 |
| 9.4.1 | <i>Autoclaving</i> | 28 |
| 9.5 | Chemical resistance..... | 28 |
| 10. | Troubleshooting..... | 29 |
| 10.1 | Opening the cover after an error | 29 |
| 10.2 | Emergency cover release..... | 29 |
| 10.3 | Unbalance..... | 30 |
| 10.4 | General errors | 30 |
| 10.5 | Error messages | 31 |
| 11. | Guarantee, repairs | 31 |
| 12. | Transport, storage, disposal | 32 |
| 12.1 | Transport and storage | 32 |
| 12.2 | Transport and storage conditions | 32 |
| 12.3 | Disposal | 33 |
| 13. | Manufacturer's information..... | 33 |
| | Distributor's information..... | 33 |
| 14. | Annexes | 33 |
| A. | Optional accessories | |
| B. | Declaration of conformity (CE, ROHS 2) | |
| C. | Declaration of decontamination (repair / return) | |
| D. | Dependency nomogram RPM / RCF | |

1. Symbols used in the manual and on the device

| Symbol | Explanation |
|---|---|
|  | WARNING! Warning of potential injury or health risk |
|  | DANGER! Risk of electric shock with potential for severe injury or death as a consequence |
|  | DANGER! Biohazard with potential for risk to health or death as a consequence |
|  | DANGER! Risk of explosion with potential for severe injury or death as a consequence |
|  | Symbol identifying a medical device for in vitro diagnostic use |
|  | CE mark |
|  | Symbol informing about the method of disposal |
|  | Please read the instruction manual before you start working with the device |
|  | Manufacturer's data |

The terms "**accessories**", "**optional accessories**" and "**equipment**" used in this manual mean the components of the centrifuge, such as: rotors, containers and reducing inserts.

2. Application

- The **MPW M-BASIC** centrifuge is a bench-top non-automatic laboratory centrifuge.
- The device is intended for In Vitro Diagnostics (IVD). This means that it is an in vitro diagnostic medical device - in accordance with the Regulation of the European Parliament and of the Council (EU) of 5 April 2017 on in vitro diagnostic medical devices and repealing Directive 98/79/EC and Commission Decision 2010 /227/EU.
- The centrifuge is used to separate aqueous solutions and suspensions of samples with a density not higher than 1.2g/cm³ taken from human, animal and plant organisms into components of different densities under the influence of centrifugal force, in order to provide information about their biological state and to other analytical work.

- The design of the centrifuge ensures ease of use, safe operation and a wide range of applications in medical, biochemical and other analysis laboratories.
- The centrifuge is not biotight, therefore, when centrifuging preparations that require biotightness, containers and rotors with a biotightness certificate should be used.

3. Technical specification

| | | | | | |
|--|---|------------|------|------|------|
| Manufacturer | "MPW MED. INSTRUMENTS" SPÓŁDZIELNIA PRACY, Boremlowska 46 Street, 04-347 Warsaw | | | | |
| Type | MPW M-BASIC | | | | |
| Catalog no (REF) | 102MB/2-56 | 102MB/1-56 | | | |
| Main's voltage (L1+N+PE), | 230V | 100V | 110V | 120V | 127V |
| | ±10% | ±5% | | | |
| Frequency | 50/60Hz | | | | |
| Device power (max.) | 120W | | | | |
| Current protection | T 2A | T 3,15A | | | |
| Capacity (max.) | 8x15ml, 2x50ml, 2xPRP(60ml) | | | | |
| Speed - RPM | 300 ÷ 4000 obr/min, (step 100 obr/min) | | | | |
| Force - RCF | 10 ÷ 2469 x g (displayed 2500 x g) step 10 x g (for value <100) step 100 x g (for value ≥100) | | | | |
| Running time | 1 ÷ 99 min., step co 1 min | | | | |
| Time counting | descending from pressing START / descending from reaching the programmed speed | | | | |
| Short-time operation mode – SHORT | yes | | | | |
| Continuous operation mode – HOLD | yes | | | | |
| Menu languages | English | | | | |
| User programs | 5 | | | | |
| Acceleration (ACEL) | FAST, SOFT | | | | |
| Deceleration (DECEL) | FAST, SOFT, LONG, RUN | | | | |
| Electromagnetic compatibility | according to EN 61326-2-6:2006 | | | | |
| Degree of protection (according to PN-IEC 34-5) | IP20 | | | | |
| Dimensions: | | | | | |
| Height (H) | 300 mm | | | | |
| Width (W) | 365 mm | | | | |
| Depth (D) | 450 mm | | | | |
| Height with open cover (Hoc) | 572 mm | | | | |
| Noise level | ≤ 56 dB | | | | |
| Weight 230V | approx. 21 kg | | | | |
| Weight 120V | approx. 23 kg | | | | |

3.1 Environmental conditions

- The device may only be used indoors.
- The permissible ambient temperature is 2°C to 40°C.
- Maximum allowed relative humidity 80% at temperature up to 31°C decreasing linearly to 50% relative humidity at 40°C.

- The mains voltage fluctuations must not exceed $\pm 10\%$ of the nominal voltage.
- Maximum altitude 2,000 m above sea level.
- Overvoltage category II.
- Pollution degree 2.

4. Installation

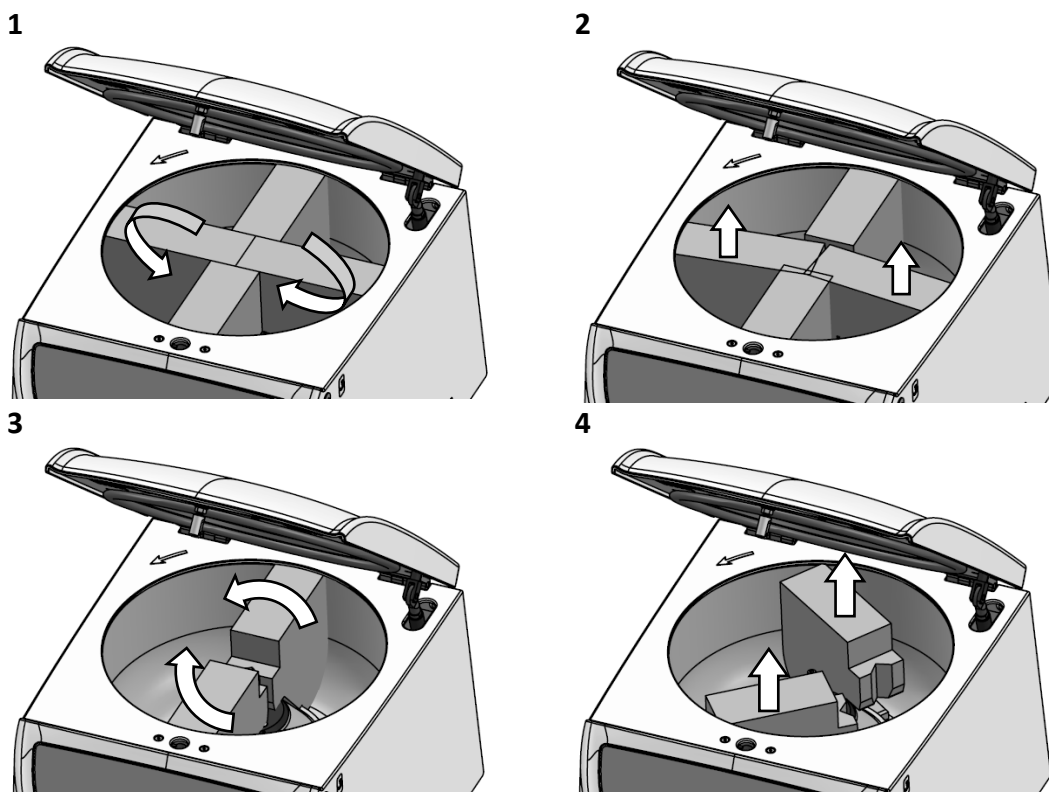

Open the package. Remove the box containing the accessories. Take out centrifuge from the container. Save the box and packing material in case of service shipment. Connect the centrifuge to the power supply and open the cover, then remove the safety locking the rotor by following the pictures below.



4.1 Content of package

| Name | pcs. | Catalog no. (REF) |
|--|------|---|
| Centrifuge MPW M-BASIC | 1 | 102MB/2-56 (230V 50/60Hz) or 102MB/1-56 (120V 50/60Hz) |
| Rotor fixing screw | 1 | 18626 |
| Rotor key | 1 | 18672 |
| Spanner for emergency opening of the cover | 1 | 18640 |
| Power cord 230V or 120V | 1 | 17866 or 17867 |
| Fuse for version 230V 50/60Hz | 4 | 18675 |
| Fuse for version 120V 50/60Hz | 4 | 18676 |
| Vaseline 20ml | 1 | 17201 |
| Permanent marker | 1 | 18678 |
| User manual | 1 | See page 1 |

4.2 Location

| | |
|---|--|
|  | <ul style="list-style-type: none"> ▪ Lifting and carrying the centrifuge by one person may lead to back injuries. There is risk of injury when lifting and carrying heavy loads. ▪ The centrifuge should be lifted and transported with a sufficient number of helpers. Use a transport aid to transport the centrifuge. ▪ The device should be lifted by its bottom and placed directly on a suitable laboratory table. ▪ The centrifuge should be set so that access to the power switch is not difficult. ▪ A safe installation site must be provided. ▪ Do not place the centrifuge near heaters and avoid direct sunlight. ▪ The table on which the centrifuge is placed should be stable and have a flat, leveled top. ▪ Leave a distance of 30 cm around the centrifuge in order to maintain the ventilation zone. Do not obstruct the ventilation openings (safety requirements in the event of an accident in accordance with EN 61010-020). ▪ The laboratory table should be cleaned before placing the centrifuge on it. ▪ The given parameters of the centrifuge are maintained for the ambient temperature range given in the technical data table. ▪ When changing the place from cold to warm, water vapor condensation inside the centrifuge will occur. It is important to allow sufficient time for drying before restarting the centrifuge (min. 4 hours). |
|  | <ul style="list-style-type: none"> ▪ The supply voltage must match the voltage specified on the rating plate. Laboratory centrifuges by MPW MED. INSTRUMENTS have a three-core connection cord with a plug resistant to dynamic loads. ▪ The power socket must have a safety pin. ▪ It is recommended to install an emergency switch which should be located far from the centrifuge near the exit from the room or outside the room. |
|  | <ul style="list-style-type: none"> ▪ Before turning the device on, make sure that it is properly connected to the power supply. Only the power cord recommended by the manufacturer may be used. |

4.3 Current protection

| | |
|---|---|
|  | <p>The centrifuge is equipped with a current protection located in the mains power socket on the rear wall of the centrifuge.</p> |
|---|---|

5. Safety

5.1 General remarks

| | |
|---|---|
|  | <ul style="list-style-type: none"> ▪ The laboratory centrifuge may be operated only by qualified laboratory personnel, after getting acquainted with the User manual. ▪ The user manual is part of the product. ▪ The user manual should always be kept in the vicinity of the centrifuge. ▪ The centrifuge cannot be operated contrary to its purpose. ▪ If the centrifuge is used in a manner inconsistent with the manufacturer's guidelines, the safety of its use may be impaired. ▪ For centrifugation in the centrifuge, use only containers and inserts provided in the list of equipment, as well as centrifuge tubes, the diameter, length and strength of which are appropriate. The use of test tubes not included in the list |
|---|---|

should be agreed with MPW MED. INSTRUMENTS or its authorized representatives.

- Pay attention to the quality and appropriate thickness of the walls of glass test tubes. Glass tubes should be centrifuge tubes, and their use in the centrifuge should be made dependent on the following guidelines:

| glass test tubes | max. RCF in angular rotors | max. RCF in horizontal rotors |
|------------------|-------------------------------|----------------------------------|
| 5-10 ml | 3000 x g | 4000 x g |
| 30-100 ml | spinning not allowed | 4000 x g |

5.2 Placing the rotor and accessories in the centrifuge



- Connect the centrifuge to the power source (mains socket at the back of the centrifuge).
- Turn on the centrifuge (switch on the back of the centrifuge).
- Open the cover of the centrifuge by pressing the COVER key. Before installing the rotor, check that the rotating chamber is free from any contamination. If there is dust, glass splinters, liquid residues, etc., remove them.
- The rotor can fall if not handled properly, therefore it should always be transported and placed in the centrifuge using both hands.
- Place the rotor on the motor axis by sliding it onto the cone as far as it will go (keeping the coaxially between the rotor and the motor axis).
- Screw the screw securing the rotor into the motor axis (clockwise), and then tighten it firmly with the rotor key.
- Fill the rotor with containers / hangers / test tubes according to recommendations in section **Filling the rotor**.
- In order to replace the rotor, first remove the tubes and containers from it, unscrew the screw securing the rotor with the enclosed rotor key, counterclockwise, then using both hands, grab the rotor on opposite sides and remove it from the motor axis.
- Install new rotor in accordance with the above instructions.

5.3 Filling the rotor

The M-BASIC centrifuge has a unique rotor that combines the advantages of traditional angular and horizontal rotors. It has two horizontal-angle sockets. This solution enables centrifuging at 45° and 90° without changing the rotor, but only by changing the position of the containers. To do this, remove the hanger and rotate it by 90° around its axis and put it back in the appropriate sockets.

Placing the pendant in the rotor sockets on the pins will result in a horizontal spin, while on the inlets - angular.

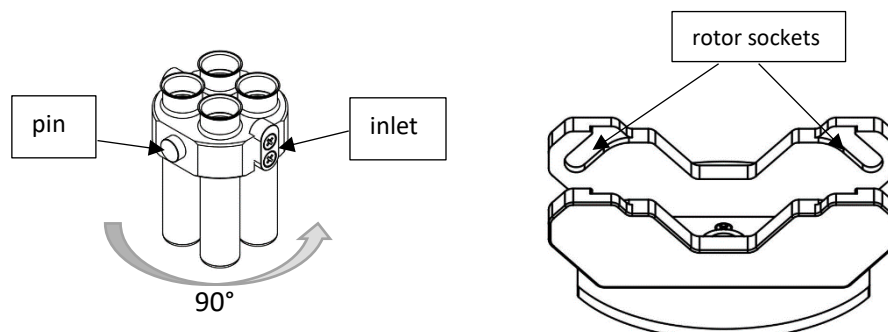

Horizontal position

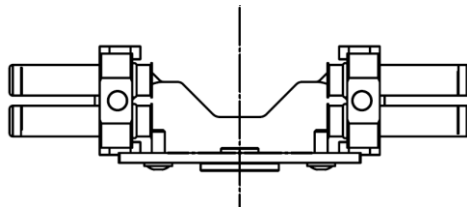

Angular position

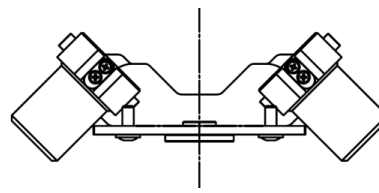

- Only containers suitable for the selected type of rotor should be used.
- **In order to ensure correct operation and increase the durability of the rotor, lubricate the rotor pins with technical petroleum jelly, which are used to suspend the containers and the pin cuts in the containers.**
- **Swinging rotors must be equipped with buckets in all seats.**
- **Do not exceed the maximum rotor load.**
- Weighing the filled test tubes into the rotor is recommended. When centrifuging in a horizontal position, it is recommended to weigh the filled containers / hangers. This will allow to minimize the differences in mass between them, and as a result to avoid the negative impact of vibrations on the engine suspension and to reduce the noise level during the operation of the centrifuge.
- Before starting the centrifugation in the horizontal position, check that all containers / hangers are properly hung and can tilt freely.
- Place empty test tubes in containers. Manually tilt the containers to the horizontal position, check that there are no collisions between the test tubes, containers / hangers and the rotor.

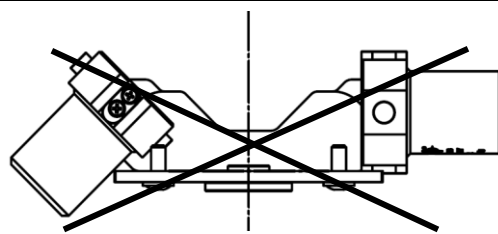
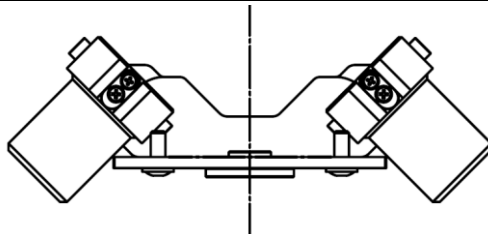
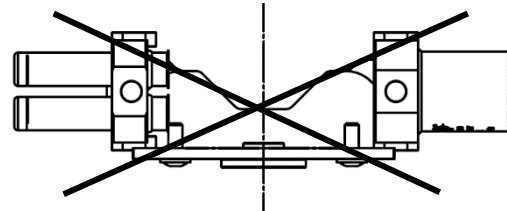
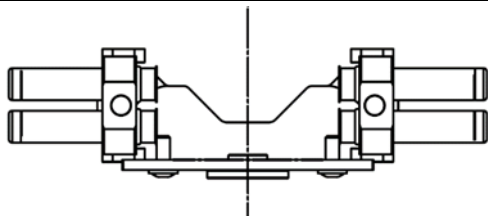

CORRECT

WRONG





5.4 Filling the tubes

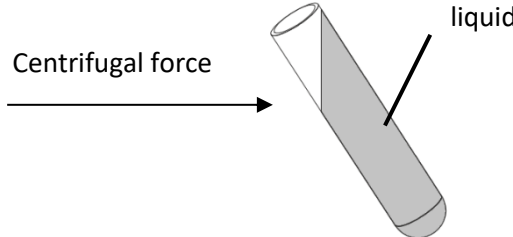
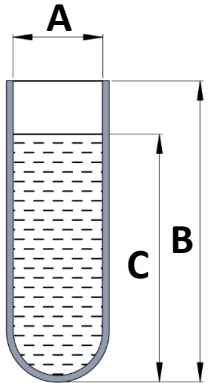

- **Tubes may only be filled outside the centrifuge.**

| | |
|--|--|
| | <div style="text-align: center;">  </div> <ul style="list-style-type: none"> If the manufacturer of the test tube has not specified the maximum level, fill the test tubes so that the centrifuged substance does not run out of the vessel during centrifugation. To do this, use the formula below: <div style="display: flex; justify-content: space-around; align-items: center;"> <div data-bbox="438 548 646 929">  </div> <div data-bbox="949 593 1085 660"> $C < B - \frac{A}{2}$ </div> </div> <div style="margin-top: 10px;"> <p>A – inner diameter of the tube B – tube height C – maximum liquid level</p> </div> |
|--|--|

5.5 Safety hints

| | |
|---|--|
|  | <p>ROTOR'S MAINTENANCE</p> <ul style="list-style-type: none"> Lubricate the rotor pins with technical petroleum jelly (supplied with the rotor) Use only accessories in good technical condition. Use accurate preventive maintenance to prevent corrosion of the equipment (see chapter <i>Maintenance</i>). |
|  | <p>MAINTENANCE OF SEALED EQUIPMENT</p> <ul style="list-style-type: none"> Make sure that the sealing rings (rubber) are covered with a thin layer of grease to maintain tightness. Use high vacuum silicone grease, e.g., "C" type by LUBRINA. |
|  | <p>DANGEROUS MATERIALS</p> <ul style="list-style-type: none"> Infectious materials should be centrifuged only in containers / rotors with covers. It is not allowed to centrifuge toxic or infectious materials, if the seal of the rotor or test tube is damaged. Proper disinfection procedures should always be carried out, if dangerous substances have contaminated the centrifuge or its accessories. |
|  | <p>EXPLOSIVE, FLAMMABLE MATERIALS</p> <ul style="list-style-type: none"> It is not allowed to centrifuge explosive and inflammable materials. Do not centrifuge substances that could create a potentially explosive atmosphere as a result of the high energy supply during centrifugation. The centrifuge cannot be used in an explosive atmosphere. It is not allowed to centrifuge materials that may generate inflammable or explosive mixtures when exposed to air. |

5.6 Operating conditions

| | |
|---|--|
|  | <p>GENERAL THOUGHTS</p> <ul style="list-style-type: none"> ▪ Only original equipment of centrifuges and spare parts should be used. ▪ In the event of a malfunction of the centrifuge, use the services of MPW MED factory service. INSTRUMENTS or its authorized representatives. ▪ It is not allowed to start the centrifuge if it is not installed properly or the rotor and accessories are not properly mounted. ▪ The centrifuge must not be transported with the rotor installed on the motor axis. ▪ Fill the rotor equipment to the same weight in order to prevent unbalance of the centrifuge (point Filling the rotor). |
|---|--|

| | |
|---|--|
|  | <p>START UP OF THE CENTRIFUGE</p> <ul style="list-style-type: none"> ▪ Before switching on the device, carefully read all sections of this manual in order to ensure the correct operation of the device and to avoid damage to the device or its accessories. |
|---|--|



| | |
|---|---|
|  | <p>CENTRIFUGAL SUBSTANCES</p> <ul style="list-style-type: none"> ▪ Impellers are designed for centrifuging liquids with an average density of 1.2 g/cm³ or less. This applies to centrifugation at maximum speed. |
|---|---|

5.7 Work safety

The centrifuge should be inspected by an authorized service at least once a year (after the warranty period). Special circumstances, e.g., corrosive environment, may be the reason for more frequent checks. Tests should end with issuing a validation protocol, which specifies checking the technical condition of a laboratory centrifuge.

It is recommended to create a document that records all repairs and inspections. This document should be kept in the place where the centrifuge is used.

| | |
|---|--|
|  | <p>INSPECTION PROCEDURES CARRIED OUT BY THE OPERATOR</p> <p>The operator must pay attention to the fact that the parts of the centrifuge, important from the safety point of view, are not damaged. This note applies to:</p> <ul style="list-style-type: none"> ▪ Centrifuge equipment, in particular structural changes, corrosion, initial cracks, abrasion of metal parts. ▪ Bolted connections. ▪ Inspection of rotor and container seals, if any. Particular attention should be paid to rubber elements (seals). In the event of any damage or visible structural changes, they should be immediately replaced with new ones. ▪ Control of the performance of annual post-warranty inspections of the technical condition of the centrifuge. |
| | <ul style="list-style-type: none"> ▪ During centrifugation, it is not allowed to lift, shift the centrifuge or rest on it. ▪ During centrifugation, you must not stay in the safety zone, i.e., 30 cm distance around the centrifuge, nor leave any objects, e.g., glass vessels, inside this zone. ▪ It is not allowed to put any objects on the centrifuge. |
| | <p>OPENING THE LID DURING SPINNING</p> |

| | |
|---|---|
|  | <ul style="list-style-type: none"> It is not allowed to use the emergency opening of the lid during spinning, because it may result in loss of health or life. |
|  | <p>HANDLING OF ROTORS</p> <ul style="list-style-type: none"> It is not allowed to use accessories (rotors, lids, containers, hangers and round carriers) with signs of corrosion or other mechanical damage. It is not allowed to centrifuge substances of high corrosive aggressiveness, which may damage the materials and reduce the mechanical properties of rotors, buckets and round carriers. |

5.8 Unbalance

| | |
|---|---|
|  | <p>Unbalance causes noise, vibration during operation and has a negative effect on the driveline (engine and suspension). The more precisely the process of balancing the feed to the rotor is carried out, the smoother the centrifuge will run and the longer the useful life of the drive system will be. In addition, due to the correct balancing, an excellent level of separation of the centrifuged substance is achieved since the extracted components will not be picked up again by vibrations.</p> |
|---|---|

The centrifuge is equipped with a rotor imbalance sensor which interrupts the centrifugation process in the event that the rotor is incorrectly loaded. In the event of its activation, the centrifugation process is stopped by quick braking and an error message is displayed. Rotor imbalance detection is discussed in more detail in the **Troubleshooting** chapter.

5.9 Emergency stop

At any time during centrifugation, it is possible to interrupt the process and stop the centrifugation with the fastest braking characteristic.

This is done by pressing the button  twice (2x).

Pressing the  key once will stop the spinning with the braking characteristics set in the program.

5.10 Residual risk

The centrifuge is built according to the state-of-the-art and the recognized safety regulations. Nevertheless, remain some level of residual risk due to improper operation and malfunctions. It is possible to decrease residual risk by strictly applying user manual conditions and correcting malfunction which could threaten safety, immediately.

6. Operating

6.1 General description

The MPW M-BASIC laboratory centrifuge is equipped with a modern microprocessor controller, durable and quiet, brushless induction motor and equipment that meets modern user requirements. The housing and cover are made of ABS, the base is made of aluminum, and the centrifugation chamber is made of stainless steel. The cover is mounted on steel hinges, and from the front it is secured against opening it during spinning with an electromagnetic lock.

6.2 Control elements

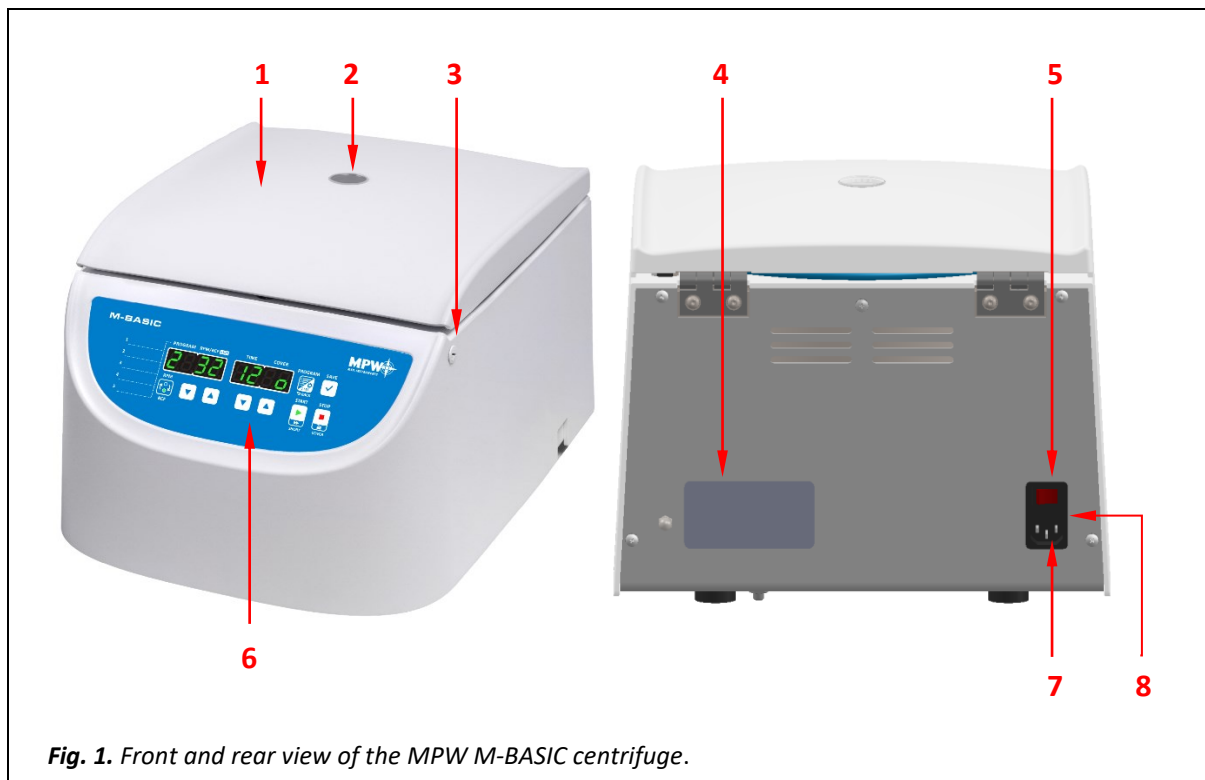
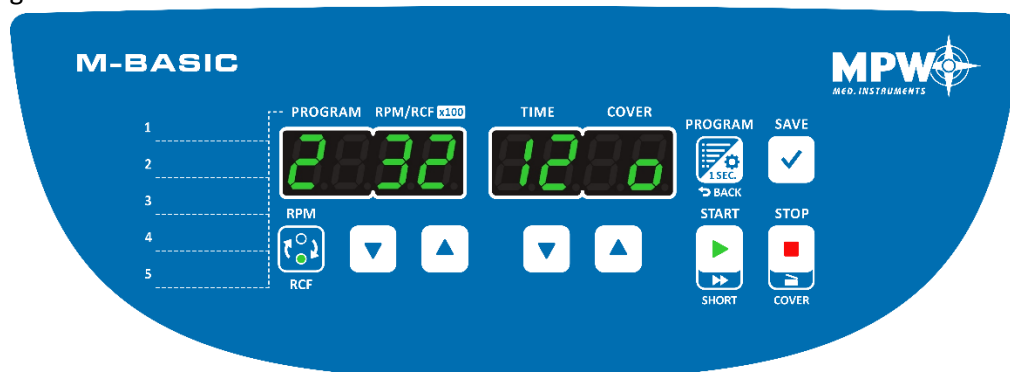



Fig. 1. Front and rear view of the MPW M-BASIC centrifuge.







- 1 Centrifuge lid
- 2 Inspection glass (is used to control the rest condition of the rotor)
- 3 Emergency cover release
- 4 Name plate
- 5 Main's switch
- 6 Control panel (display and control of the centrifuge operation)
- 7 Centrifuge power socket
- 8 Fuse's socket

6.3 Control panel

The control panel located on the front wall of the casing is used to control the operation of the centrifuge.



| | | |
|---|--------------------------|---------------------------|
|  | START | start spinning |
| | SHORT¹ | short-term centrifugation |
|  | STOP² | spin stop |
| | COVER | opening the cover |

| | | |
|---|---|---|
|  | SAVE | save the set centrifugation values under the program number / enter the service menu (hold for 8 sec.) |
|  | PROGRAM | program selection / entering advanced program parameters (hold for 1 sec.) / back |
|  | UP | increase value / menu navigation |
|  | DOWN | decrease value / menu navigation |
|  | RPM/RCF | change display RPM / RCF |
|  | Fields for the description of programs | It is possible for the user to manually describe the program on the control panel. For this purpose, use the pen included in the kit (catalog number 18678). For cleaning, use a soft cloth moistened with a liquid based on isopropyl alcohol. |

¹ hold down the key.

² first press - spin stop with the currently selected deceleration characteristic, second press - the fastest possible stop.

6.4 Name plate

The data concerning the device should be read from the rating plate located on the rear wall of the centrifuge (the picture below is an example).

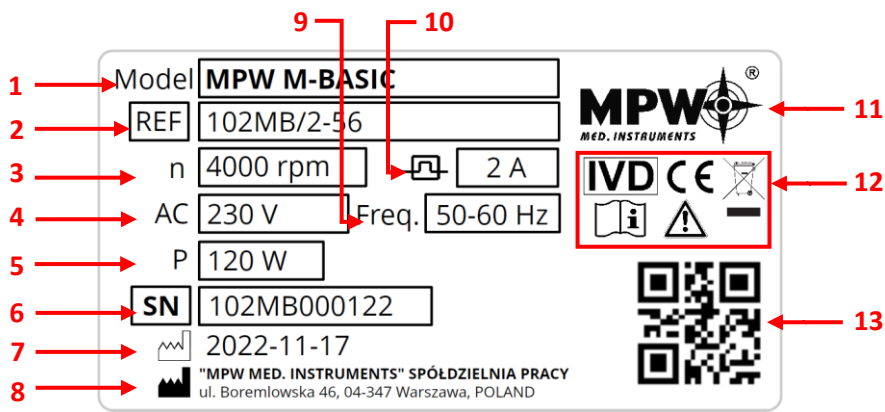
| | |
|---|---|
|  | |
| <p>1 Centrifuge model</p> <p>2 Catalog number</p> <p>3 Maximum speed</p> <p>4 Rated voltage</p> <p>5 Maximum rated power</p> <p>6 Serial number</p> <p>7 Date of production</p> | <p>8 Manufacturer's information</p> <p>9 Rated frequency</p> <p>10 Current protection</p> <p>11 Manufacturer's logo</p> <p>12 Approval marks and symbols (explained in chapter 1)</p> <p>13 QR code for serial number</p> |

6.5 Control device

The microprocessor control system used in the centrifuge ensures a wide range of setting, implementing and reading operating parameters.

6.6 Entering parameters

The system for setting and reading parameters is a keyboard with clearly accessible control elements and a display. Easily readable indicators signaling the performed operations make it easier for the operator to program and register parameters and the state of the device.

6.7 Safety features



Cover lock

The centrifuge can be started only with properly closed cover. The cover can only be opened when the rotor has stopped. In case of emergency opening of the cover during operation, the centrifuge will immediately start braking to a complete stop.

Unbalance detecting

If an uneven load is detected during the operation of the centrifuge, the drive is turned off. An error message will appear on the display.

Rest state inspection

Opening of the centrifuge's cover with **COVER key** is possible only with the rotor in the state of rest. Check that the symbol in the COVER field is continuously lit on the screen . Use the visor on the cover to make sure the impeller is not turning. Symbol when rotor brakes  flashes. Emergency opening of the cover during rotor spinning is not allowed

Emergency opening of the cover during rotor spinning is not allowed!

6.8 Temperature increase

Temperature in the centrifugation chamber, rotor temperature, sample temperature may exceed 40°C, depending on the centrifugation time, RPM / RCF and ambient temperature.

7. Control elements

7.1 Program selection

The centrifuge has the ability to save 5 programs. Program selection is done by pressing the

PROGRAM button  until the desired program number is obtained.

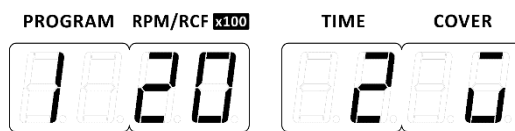

7.2 Default settings

By default, all programs are assigned the following default values:

- **RPM = 2000** [obr/min] – revolutions per minute
- **TIME = 2** [min] – spinning time

Parameters present in the **Advanced program parameters** menu:

- **ACC. = FAST** – acceleration characteristics
- **DEC. = SOFT** – deceleration characteristic
- **COV. = ON** – automatic lid opening after completion of spinning – set on
- **T.CNT. = SPD** – countdown of time from reaching the set rotational speed
- **SND. = ON** – sounds on – (the parameter is not saved by the programs)

7.3 Unit selection - RPM / RCF

The display of the RPM and RCF units is changed using the **RPM / RCF button** . The currently selected information will be displayed, and then its value.

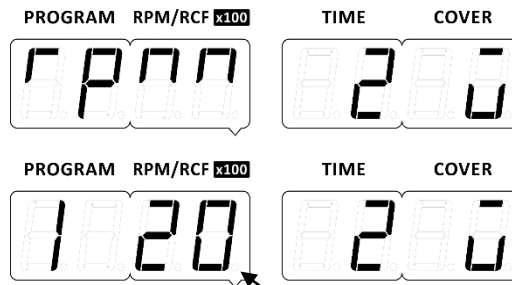



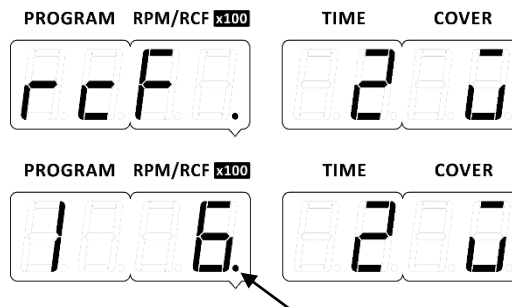

The **RPM** value is displayed without a dot (picture above), while the **RCF** value is shown with a dot as in the image below.



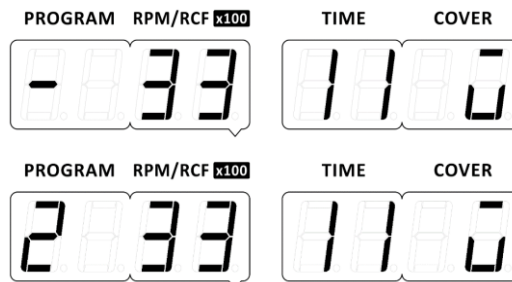

7.4 Editing the program

By changing the speed, time or advanced settings of the program, its edition begins, which is signaled by the flashing of the program number in the **PROGRAM** field.



The program is edited with the direction keys   under the appropriate set field - (RPM / RCF) / (TIME). After setting the desired parameters, confirm with the **SAVE** button . The program will be saved under the previously selected number.



7.4.1 Spin speed adjustment (RPM)

Spinning revolutions can be adjusted in the range of **300 ÷ 4000 RPM** using the direction keys   under the RPM / RCF field. The speed change step is 100 rpm.

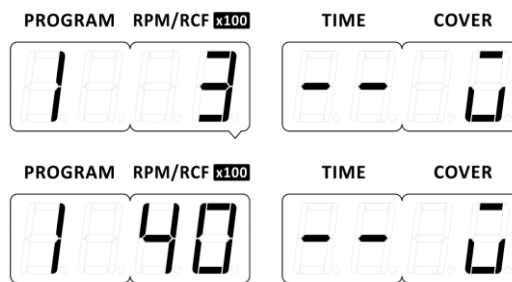
The actual spin speed is **100 times** faster than the centrifuge displayed on the screen. The pictures below display **300 RPM** and **4000 RPM**.





7.4.2 Relative centrifugal force adjustment (RCF)

The relative centrifugal force of the RCF can be adjusted in the range of $10 \div 2500$ (x g) using the directional keys   below the RPM / RCF field. The **RCF** value is shown with a dot. The RCF step is **10** (x g) with values below 100, and above 100 the step is **100** (x g).

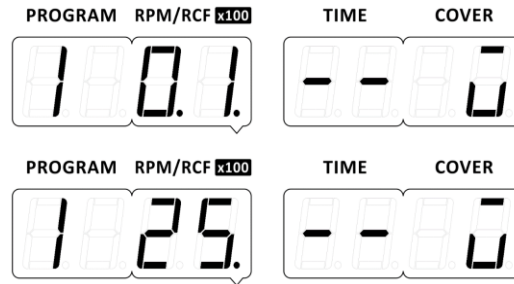
The actual value is **100 times** greater than the centrifuge displayed on the screen. The pictures below show **10 RCF** and **2500 RCF**.





7.4.3 Spin time adjustment

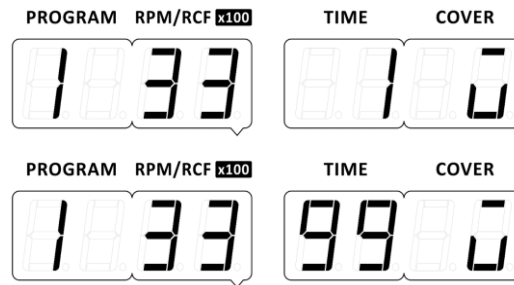



The spin time can be adjusted from $1 \div 99$ minutes by using the directional buttons   below the TIME field. The time change step is 1 min.





7.5 Advanced program parameters

Entering the advanced parameters of the program is done by holding down the **PROGRAM** button . Return to the basic settings is done by pressing the **PROGRAM** button .

The possible screens after entering the advanced program parameters are shown in the table below.

Selecting the adjustable parameter is done by pressing the direction buttons   in the RPM / RCF field and changing the value by pressing the direction buttons   in the TIME field.

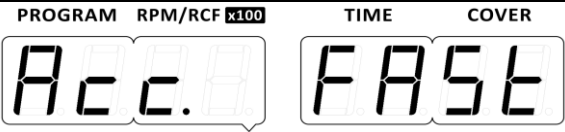
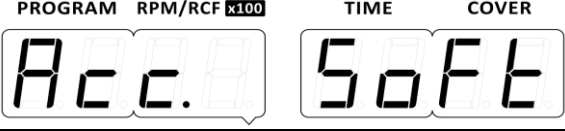
From the advanced settings you can save the program with the **SAVE** button .



| Parameter / Value | Description |
|---|-------------------|
|  | fast acceleration |
|  | soft acceleration |
|  | fast deceleration |

| | | |
|-----------------------------|------------|--|
| PROGRAM RPM/RCF x100 | TIME COVER | soft deceleration |
| dEc. | SoFt | |
| PROGRAM RPM/RCF x100 | TIME COVER | long deceleration |
| dEc. | LoNg | |
| PROGRAM RPM/RCF x100 | TIME COVER | run deceleration |
| dEc. | ruN | |
| PROGRAM RPM/RCF x100 | TIME COVER | automatic opening of the lid after spinning enabled |
| coU. | oN | |
| PROGRAM RPM/RCF x100 | TIME COVER | automatic opening of the lid after spinning disabled |
| coU. | oFF | |
| PROGRAM RPM/RCF x100 | TIME COVER | time counting from reaching the set speed |
| t.cnt. | SPd. | |
| PROGRAM RPM/RCF x100 | TIME COVER | time counting from pressing START button |
| t.cnt. | StRt. | |
| PROGRAM RPM/RCF x100 | TIME COVER | acoustic signals off (not memorized in the program) |
| Snd. | oFF | |
| PROGRAM RPM/RCF x100 | TIME COVER | acoustic signals on (not memorized in the program) |
| Snd. | oN | |

7.6 Service menu

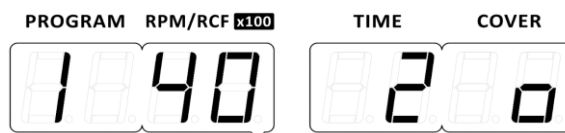

The service menu is displayed by holding the **SAVE** button  for **8 seconds** from the main screen level (in the loaded program mode).



Changing the displayed parameters is done by pressing the direction buttons   (RPM / RCF). Exit and confirmation of selected menu parameters is done by pressing the **SAVE** button .

The table below shows the structure of the service menu.

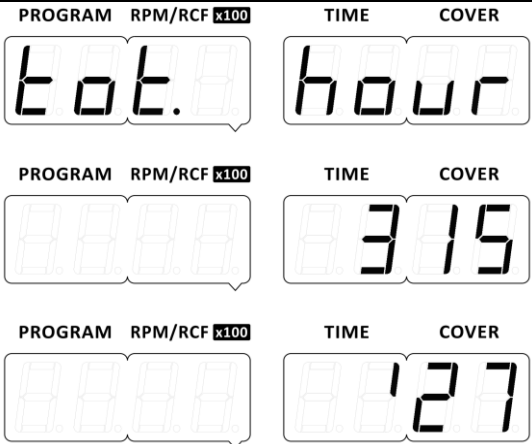
| Screen | Description |
|---|--|
| <p>PROGRAM RPM/RCF x100 TIME COVER</p> <p>PROGRAM RPM/RCF x100 TIME COVER</p> | <p>Program version</p> <p>Driver program version (example)</p> <p>Control module version (example)</p> |
| <p>PROGRAM RPM/RCF x100 TIME COVER</p> <p>PROGRAM RPM/RCF x100 TIME COVER</p> <p>PROGRAM RPM/RCF x100 TIME COVER</p> | <p>Factory reset</p> <p>When the word "rESEt" appears on the screen, this is the question to which the answer ("YES" or "no") is selected with the direction keys (PROGRAM). The SAVE key confirms the selection and restores the factory settings or returns to the Menu.</p> |
| <p>PROGRAM RPM/RCF x100 TIME COVER</p> <p>PROGRAM RPM/RCF x100 TIME COVER</p> <p>PROGRAM RPM/RCF x100 TIME COVER</p> | <p>Rotor cycle counter</p> <p>It is the information to display the message "r.cYc. 500 ". The allowed number of cycles is 70000. The counter counts down from 70000 to 0.</p> <p>The counter can be reset by pressing the SAVE button .</p> <p>Pressing the direction keys (PROGRAM) changes the response to "rESEt YES" or "rESEt NO".</p> <p>Pressing SAVE on the answers "rESEt YES" will return the counter to the value of 70000 cycles, and on "rESEt NO" will return to the display of the counter.</p> |
| <p>PROGRAM RPM/RCF x100 TIME COVER</p> <p>PROGRAM RPM/RCF x100 TIME COVER</p> | <p>Centrifuge cycle counter</p> <p>Information on the number of spin cycles. No defined allowed number of cycles, no message associated with this counter.</p> <p>The counter counts the cycles in ascending order from "0".</p> <p>In the example given, 348 cycles.</p> |

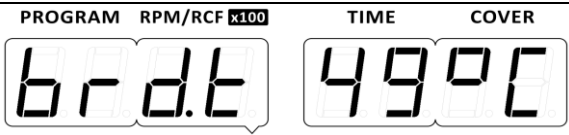
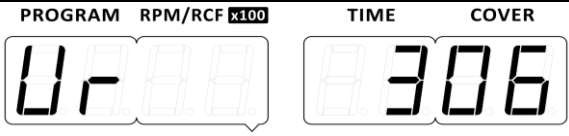
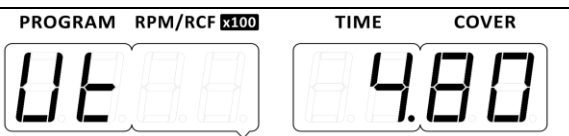
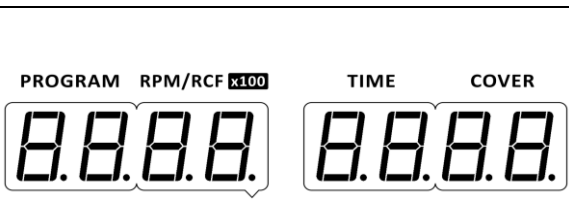
| | |
|---|--|
| | It is not possible to reset the centrifuge cycle counter. |
|  | <p>Total spin time counter</p> <p>The first value displayed is expressed in hours. Pressing the arrows   in the TIME section will show the time in minutes, which should be added to the display of full hours to get the total spin time, e.g., "27".</p> <p>In the given example, it is a total of 315h and 27min.</p> <p>It is not possible to reset the centrifuge operation time counter.</p> |
|  | <p>PCB temperature measurement</p> <p>Temperature information on electronics.</p> |
|  | <p>Measurement of the DC voltage supplying the inverter</p> <p>Information about voltage on electronics.</p> |
|  | <p>Measure voltage proportional to the temperature of the inverter power module</p> <p>Information about voltage on electronics.</p> |
|  | <p>Display and beeps test</p> <p>When you stop at this screen, all possible segments will be shown on both displays and an audible signal will sound to check if it is functioning properly.</p> |

8. Centrifuging

| | |
|---|--|
|  | <p>Before starting the centrifugation, make sure that the rotor is properly seated and firmly screwed to the motor axis.</p> |
|---|--|

8.1 Centrifuging with set time

8.1.1 Start centrifuging

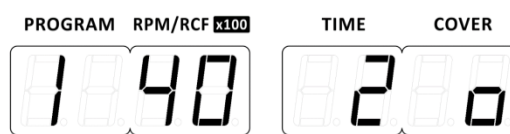



After setting appropriate spin parameters, described in chapter *Control elements*, press button



and then . The rotor will start to accelerate.

During acceleration in the COVER field, dashes from bottom to top flash one by one, informing that the rotor speed is increasing to the set speed,



in the **TIME** field, a dot is displayed next to the minutes value (it means waiting for the countdown of time to start, if the countdown of time from reaching the set speed is set). When the rotor reaches the set speed, the symbol in the **COVER** field starts to spin.



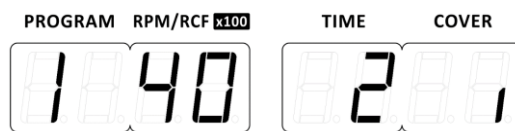

After reaching the set rotational speed, the set spin time is measured. A countdown minute is displayed with a blinking dot for seconds, when the last minute is exceeded, seconds are displayed without a dot. During the centrifugation, the current value of RPM set for the test is displayed and the symbol in the **COVER** window is spinning all the time.



8.1.2 Braking

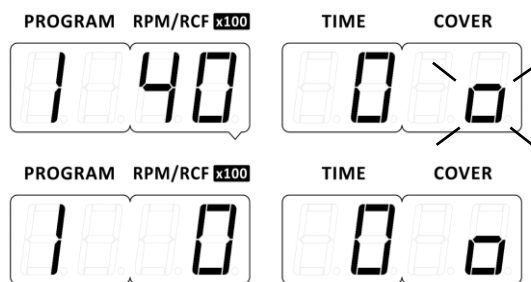

During braking, the rotor starts to brake after the time set for spinning has expired. During braking, the value in the Time field displays the time zero and the symbol  flashes.

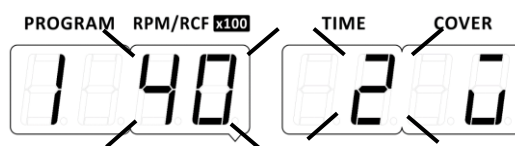

The stop of the rotor from the program is signaled by the simultaneous flashing of the **RPM / RCF** and **TIME** values. Flashing in the picture is marked by dashes deviating from the appropriate parameter. When the speed reaches zero, the lid is automatically opened (if so, set in the advanced options). The **COVER** field displays the symbol of an open cover – .



It is possible to centrifuge with an alternative unit to the centrifugal speed which is the relative centrifugal force RCF. The parameter change is described in section **Unit selection RPM / RCF**.

As in the case of centrifugation with the RPM unit, the centrifugation procedure with RCF parameter is analogous. After setting the appropriate spin parameters referring to the previous sections of this manual, press the **SAVE** button  and then **START** button . The rotor will start to accelerate. The dot at the value in the RPM / RCF field informs us that the **RCF parameter is set**.





8.1.3 Stop centrifuging

STOP symbol -  displayed continuously means closed cover when rotor is stopped.

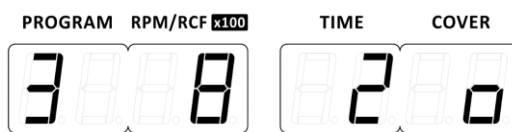
Example below: Third program with closed cover when rotor is stopped:



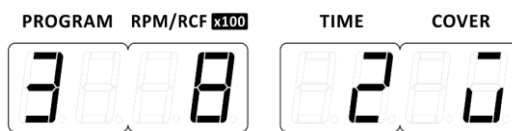

The cover is opened with the **STOP / COVER** button  after the rotor is completely stopped. The symbol  changes to the symbol for the lid open . Example of display below.



8.2 SHORT mode



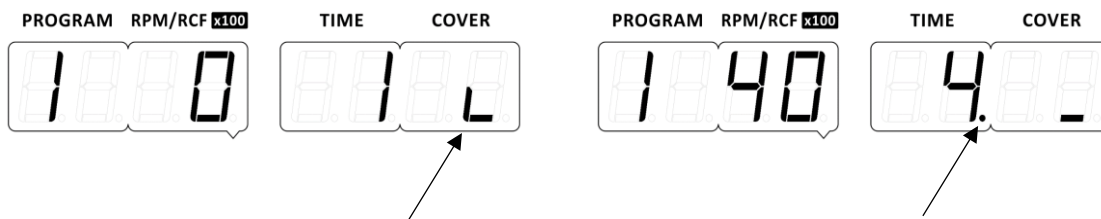

SHORT mode is activated by pressing and holding the **START / SHORT** key . The difference between SHORT mode and normal operation is that in SHORT mode spinning lasts as long as the user holds the SHORT key. The spin parameters are set as needed, just like during a normal spin.

After pressing and holding the **START / SHORT** key , the centrifuge starts to accelerate, the revolutions from zero begin to increase until the set value is reached and the time in seconds begins to measure. The symbol  starts spinning (picture on the left). When the countdown timer approaches one minute, one minute appears with a blinking dot - seconds. After exceeding one minute, "2." appears, the next values are the next counted minutes (the centrifuge measures the seconds in the background - picture on the right).



8.3 Continuous spin mode (HOLD mode)

The centrifuge has the option of endless time centrifugation. A continuous spin mode - **HOLD** was created for this purpose. It works until the user interrupts it with the **STOP** button . To start centrifugation in the continuous spin mode, set the value in the **TIME** field to two dashes using the

direction keys   under the TIME field and then press the **START** key . (If you want to save the program in HOLD mode, confirm with the **SAVE** button  before pressing **START**)

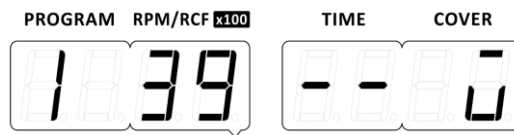

8.4 Cancel the centrifugation

If the **STOP** key  is pressed **once** during acceleration or proper centrifugation, the centrifuge will start to brake with the characteristics selected in options, the remaining time will be displayed (minutes without a dot).

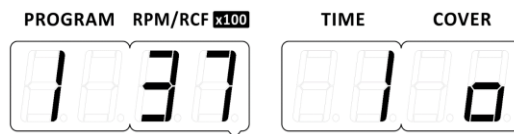



Pressing the **STOP** key  **twice** during acceleration or proper spinning, the centrifuge will start to decelerate with the fastest possible characteristic.

Manually cancel the centrifugation causes that the lid does not open automatically (despite such a setting in advanced parameters) and is signaled by alternating blinking of **RPM / RCF** and **TIME** values. Flashing in the picture is marked with dashes deviating from the corresponding symbol.



8.5 Changing parameters during centrifuging

During centrifugation, it is possible to change parameters **RPM**, **RCF** and **TIME**, but only when centrifuging from an **unsaved program**.

This is done by entering values with the direction arrows  . After each change, the centrifuge waits approx. 2 seconds for the next values. After the time has elapsed without pressing any key, the device starts to implement the change, which is signaled by the flashing of the changed values, when the sounds are turned off. On the other hand, when the sounds are turned on, the blink is accompanied by an acoustic signal played at the moment of the blink. Flashing in the picture is marked by dashes deviating from the appropriate parameter.

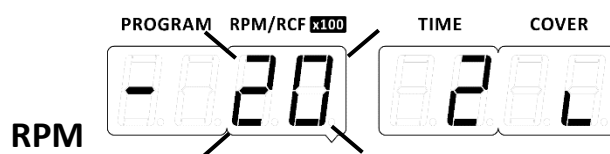

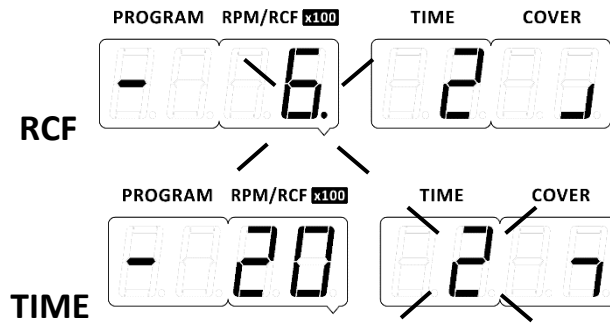

9. Service life, maintenance and chemical resistance

9.1 Service life of equipment

The rotor and containers have a lifetime of **70000 cycles** or **10 years**, whichever comes first.

After exceeding **69500** cycles (from 500 to 0 remaining cycles), each time the device is turned on, a message will be displayed informing about the number of remaining cycles, and additionally, every **50 cycles**, also before starting the centrifugation. When the rotor cycles have run out, the message will be displayed before each spin start.

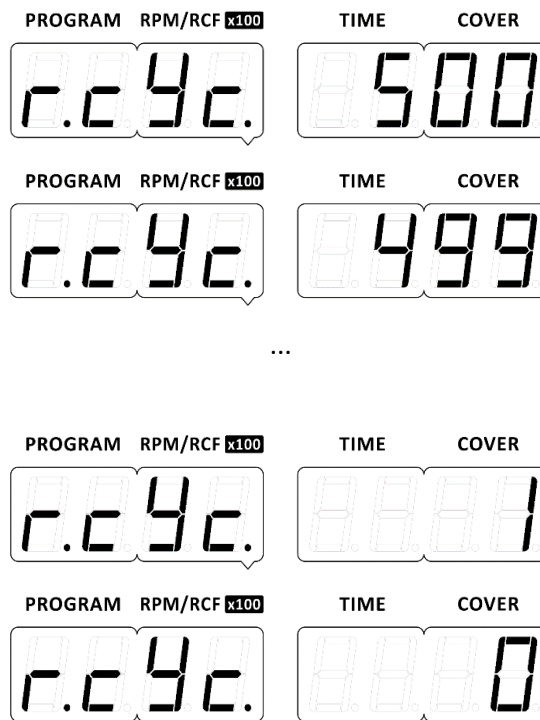

After exceeding 70000 rotor operation cycles (the value of 0 in "r.cYc." will appear) or **10 years** after the purchase of the device or the rotor with accessories, **it is absolutely necessary to replace the rotor and its accessories due to wear.**

After replacing the rotor and accessories with new ones, the "cYc" counter must be reset, referring to the description in the table under the item **Service menu**. The counter will again show the allowed number of cycles as below:

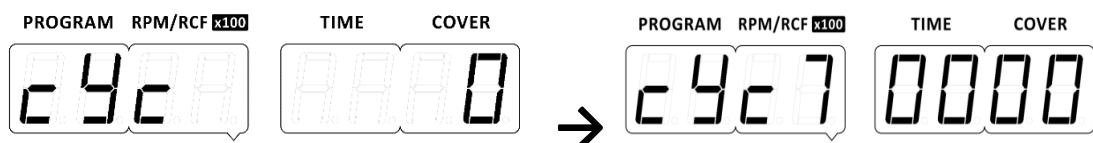

9.2 Maintenance of the centrifuge

| | |
|---|---|
|  | <ul style="list-style-type: none">▪ Before any activities related to cleaning, maintenance or disinfection of the centrifuge, disconnect the centrifuge from the power supply.▪ Before using any cleaning, disinfection or maintenance procedures other than those recommended in the instruction manual, contact the manufacturer for information as to whether the procedure in question will not damage the device.▪ Use water or other mild, water-soluble cleaning agents for cleaning.▪ Aggressive and corrosive substances should be avoided. Do not use alkaline solutions, flammable solvents, or agents containing abrasive particles.▪ Do not lubricate the centrifuge motor shaft.▪ The unused centrifuge should be left with the lid open. <p>Once a day</p> <ul style="list-style-type: none">▪ Remove water from the centrifugation chamber (water condensation due to temperature differences, or other liquids coming from test tubes) and dirt with a cloth.▪ Do not allow any liquid to enter the housing. <p>Once a month</p> <ul style="list-style-type: none">▪ Check the condition of the rotor mounting screw thread. If damaged, it must be replaced.▪ Check the condition of the centrifuging chamber, and in the event of damage being found, contact the authorized service representative of the manufacturer. |
|---|---|

9.3 Maintenance of equipment

Cleaning of the equipment

| | |
|---|--|
|  | <p>The equipment must be maintained regularly to ensure safe operation:</p> <ul style="list-style-type: none">▪ Rotor, buckets and carriers are constantly subjected to high stresses resulting from the centrifugal force. Chemical reactions and corrosion can destroy metals from which the components of the centrifuge are made. Hard-to-see surface cracks may enlarge and weaken the material without visible symptoms.▪ In the event of surface damage, crevice or other change, including corrosion, the part (rotor, container, etc.) must be replaced immediately.▪ The rotor, including the fixing screw, buckets and round carriers must be regularly cleaned to prevent corrosion.▪ The equipment should be cleaned outside the centrifuge once a week, and in case of visible dirt, immediately after use. To clean them, use neutral agents with a pH value in the range 6 ÷ 8. Alkaline agents with a pH value > 8 must not be used. Then these parts should be dried with a delicate cloth or in a chamber dryer at a temperature of about 50 ° C.▪ Keeping the equipment clean significantly extends the operating time and reduces the susceptibility to corrosion. Accurate maintenance increases service life and prevents premature failure of the rotor. |
|---|--|

| | |
|--|--|
| | <ul style="list-style-type: none"> ▪ Minimize the time of immersion in each solution according to laboratory standards. ▪ Equipment made of metal (including aluminum) must be protected against corrosive substances. ▪ Corrosion and damage due to insufficient maintenance cannot be the basis of claims against the manufacturer. |
|--|--|

9.4 Sterilization

Plastics – legend to abbreviations

| | | | |
|--------------|---------------------------|--------------|--|
| PS | polystyrene | ECTFE | ethylene/chlorotrifluoroethylene |
| SAN | styrene-acrylonitrile | ETFE | ethylene/tetrafluoroethylene |
| PMMA | polymethyl methacrylate | PTFE | polytetrafluoroethylene |
| PC | polycarbonate | FEP | tetrafluoroethylene/perfluoro propylene |
| PVC | polyvinyl chloride | PFA | tetrafluoroethylene/perfluoroalkyl vinyl |
| POM | acetal polyoxymethylene | FKM | fluorocarbon rubber |
| PE-LD | low density polyethylene | EPDM | ethylene propylene diene |
| PE-HD | high density polyethylene | NR | natural rubber |
| PP | polypropylene | SI | silicon rubber |
| PMP | polymethyl pentene | | |

One can use all standard disinfectants. Centrifuges and devices are made of different materials, one should consider their variety.

| | radiation β radiation γ 25 kGy | C_2H_4O (Ethylene oxide) | formalin, ethanol |
|-------------|---|-------------------------------|----------------------|
| PS | ● | ○ | ● |
| SAN | ○ | ● | ● |
| PMMA | ● | ○ | ● |
| PC | ● | ● | ● |
| PVC | ○ | ● | ● |
| POM | ● | ● | ● |
| PE-LD | ● | ● | ● |
| PE-HD | ● | ● | ● |
| PP | ● | ● | ● |
| PMP | ● | ● | ● |
| ECTFE, ETFE | ○ | ● | ● |
| PTFE | ○ | ● | ● |
| FEP, PFA | ○ | ● | ● |
| FKM | ○ | ● | ● |
| EPDM | ○ | ● | ● |
| NR | ○ | ● | ● |
| SI | ○ | ● | ● |
| ● | can be used | | |
| ○ | do not use | | |

In the centrifuge, disinfectants and cleaning agents generally used in medical care should be used (e.g., Aerodesina-2000, Lysoformin 3000, Melseptol, Melsept SF, Sanepidex, Cutasept F).

9.4.1 Autoclaving

- Rotors, buckets and round carriers can be sterilized in autoclave with temperature 121°C during 20 min (215 kPa), unless otherwise specified in the OPTIONAL ACCESSORIES.
- During sterilization (autoclaved) by means of steam one should consider temperature resistance of individual materials.
- Deformation of the accessories (carriers or lids made of plastic) may occur during autoclaving.
- Do not autoclave disposable materials (e.g., tubes, cyto-container).
- The life of the accessory depends on the frequency of autoclaving and use.
- Autoclaving reduces lifespan of plastic and mechanical components. PC tubes can become useless.
- Pressure in closed containers can cause plastic deformation or explosion.
- Prior to autoclaving the rotors and accessories, thoroughly wash and rinse with distilled water.
- Never exceed the permissible autoclaving temperature and time.

Chemical resistance of plastics

| | autoclaving 121 °C, 20 min | | autoclaving 121 °C, 20 min |
|-------|--|----------------|----------------------------------|
| PS | ○ | PMP | ● |
| SAN | ○ | ECTFE, ETFE | ● |
| PMMA | ○ | PTFE | ● |
| PC | ● | FEP, PFA | ● |
| PVC | ○ ¹⁾ | FKM | ● |
| POM | ● | EPDM | ● |
| PE-LD | ○ | NR | ○ |
| PE-HD | ○ | SI | ● |
| PP | ● | | |
| ● | may be used | | |
| ○ | cannot be used | | |
| 1) | except PVC hoses which are resistant to the steam sterilization in the temperature 121 °C. | | |

9.5 Chemical resistance

Chemical resistance of plastics



| | aldehydes | cyclic alcohols | esters | ether | ketones | strong or concentrated acids | weak or diluted acids | oxidizing substances | cyclic hydrocarbons | ahs | haloid hydrocarbons | alkalis |
|-------|-----------|-----------------|--------|-------|---------|------------------------------|-----------------------|----------------------|---------------------|-----|---------------------|---------|
| PS | ○ | ● | ○ | ○ | ○ | ○/● | ○/● | ○ | ○ | ○ | ○ | ● |
| SAN | ○ | ● | ○ | ○ | ○ | ○ | ○/● | ○ | ○ | ○ | ○ | ● |
| PMMA | ○/● | ● | ○ | ○ | ○ | ○ | ○/● | ○ | ○/● | ○ | ○ | ○ |
| PC | ○/● | ● | ○ | ○ | ○ | ○ | ○/● | ○ | ○/● | ○ | ○ | ○ |
| PVC | ○ | ● | ○ | ○ | ○ | ● | ● | ○ | ● | ○ | ○ | ● |
| POM | ○/● | ● | ○ | ● | ● | ○ | ○ | ○ | ● | ● | ● | ● |
| PE-LD | | ● | ● | ● | ○/● | ● | ● | ○ | ● | ● | ● | ● |
| PE-HD | ● | ● | ○/● | ○/● | ○/● | ● | ● | ○ | ● | ○/● | ○/● | ● |
| PP | ● | ● | ○/● | ○/● | ○/● | ● | ● | ○ | ● | ○/● | ○/● | ● |

| | | | | | | | | | | | | |
|-------------------|-----|---|-----|---|-----|---|-----|-----|-----|-----|-----|-----|
| PMP | o/• | • | o/• | | o/• | • | • | o | o/• | o | o | • |
| ECTFE, ETFE | • | • | • | • | o | • | • | • | • | • | • | • |
| PTFE, FEP, PFA | • | • | • | • | • | • | • | • | • | • | • | • |
| FKM | • | o | o | o | o | o | • | o/• | o/• | o/• | o/• | o/• |
| EPDM | • | • | o/• | o | o/• | • | • | o/• | o | o | o | • |
| NR | o/• | • | o/• | o | o | o | o/• | o | o | o | o | • |
| SI | o/• | • | o/• | o | o | o | o/• | o | o | o | o | o/• |

| | | |
|-----|-----------------|---|
| • | very good | Permanent action of the substance for 30 days does not cause damage. |
| o/• | good to limited | Continuous action of the substance causes insignificant and partly reversible damage through the period of 7-30 days (e.g., puffing up, softening, reduced mechanical durability, discoloring). |
| o | limited | The material should not have the continuous contact with the substance. The immediate occurrence of damage is possible (e.g., the loss of mechanical durability, deformation, discoloring, bursting, and dissolving). |

Standard disinfectants can be used. Centrifuges and accessories are made of a variety of materials, the diversity of which should be considered.



Do not use chlorine bleach to clean the aluminum impellers.

| | |
|---|--|
|  | Danger! To prevent infectious materials from getting inside the centrifuge, it is necessary to use biotight certified test tubes during centrifugation. |
|  | In case of contamination of the rotating chamber or external elements of the centrifuge with hazardous materials, the user is obliged to disinfect it properly. Protective gloves must be worn during the above works. |

10. Troubleshooting

10.1 Opening the cover after an error

If the rotor is stopped due to an error, the cover will not open automatically.

If the cover cannot be opened at all, make sure that the symbol  on the display is spinning, and that after pressing the **STOP / COVER** key  it starts **blinking**. Wait for the rotor to stop and the symbol  to light up continuously.

If the cover still cannot be opened, refer to the section **Emergency cover release**.

10.2 Emergency cover release

| | |
|---|--|
|  | EMERGENCY COVER RELEASE Attention! <i>The cover may be opened in emergency only when the rotor is at rest. Before emergency opening the cover, switch off the mains power switch and disconnect the power cord. Wait 10 min and/or looking through the sight glass, make sure that the rotor is not rotating.</i> It is possible to open the cover manually (e.g., in the event of a power failure). There is a plug on the right side, which must be unscrewed counterclockwise using the emergency lid release key (catalog number 18640). Then pull on the cap until the cover is open. |
|---|--|

10.3 Unbalance

If the imbalance sensor is triggered, the spin process will be stopped by quick braking and an error message will be displayed as shown in the picture below. The symbol in the **COVER** field will blink (the blinking in the picture is marked with dashes deviating from the corresponding symbol), an audible signal will alarm the imbalance and the rotor will start to brake.

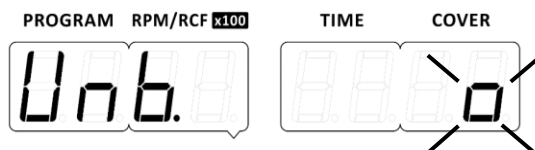

Erasing the error message is possible only after stopping the rotor by pressing one of the

following buttons: , ,  and .

To restart spinning **it is necessary to open the lid**. Then make sure that the rotor has been properly loaded - places in the rotor must be equipped with identically filled containers, inserts and test tubes so as to obtain the best possible weight balance (see chapter **Filling the rotor**). If necessary, correct the load distribution and / or in the case of horizontal rotors, clean and lubricate the rotor pins, then close the cover and restart the spinning process. If not, a message will be displayed when the

button  is pressed:

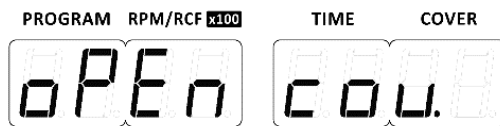







10.4 General errors

In the event of an error, messages regarding all errors will be displayed. The presentation method consists in displaying the inscription "Err." along with a numerical value. Error messages do not go out automatically and require user response.

Most errors can be cleared by switching the centrifuge off and on again. After switching the centrifuge on, the parameters of the last used program should appear.

In the event of a **short-term power failure**, the centrifuge completes the cycle with the shortest deceleration characteristic and then displays a power failure message.

| Problem | Question | Answer |
|---|--|--|
| Centrifuge cannot be started | <i>Is the power cord connected properly?</i> | Connect the power cord. |
| | <i>Is the power socket switch on?</i> | Turn on the power. |
| Centrifuge does not start program (No reaction to the START button) | <i>Is the symbol  spinning on the screen?</i> | The spin cycle is running. Press the STOP key or wait for the cycle to end. |
| | <i>Is the symbol  blinking on the screen?</i> | Rotor brakes, wait for the rotor to stop (the symbol  stops blinking). |
| | <i>Is the symbol  displayed?</i> | Close the cover, the symbol  changes to  . |

10.5 Error messages

The table below lists the possible errors that may occur during operation.

| Error number | Error name | Cause | Symptoms | Error removal |
|----------------------------------|---|---|---|--|
| Err. 01 or blank screen | No communication with the control panel | Damage to the cable connecting the control panel with the controller. | No response to keys | Reconnection of power or call for service |
| Err. 02 | No signal from the RPM sensor | Mechanical blockage of the rotor, damage to the speed sensor or its cable, damage to the electronics, damage to the motor, the centrifuge may not be level, the centrifuge may not move during operation. | After starting the centrifugation cycle, no speed increase is shown on the display. Long beep | Power up again, open and close the lid, level the device, service repair |
| Err. 04 | Engine overheating | It is created when the sensor detects too high a temperature. | Interruption of the spin cycle, engine shutdown. Coasting braking. Long beep | Reconnection of power or call for service |
| Err. 06 | Exceeding the set speed | When the measured rotor speed is 500 rpm higher than the set speed in the normal cycle or the maximum speed in edit mode during the cycle | Emergency braking (very fast) | Reconnection of power or call for service |
| Err. 07 | Emergency cover opening during spinning | After using the emergency lid release mechanism or in the event of a lock failure | Emergency braking (very fast) | Reconnection of power or call for service |
| Err. 08 | Power failure during cycle | After temporarily turning the power off and on again during the spin cycle | Emergency braking (very fast) | Reconnection of power |

11. Guarantee, repairs

The manufacturer provides the buyer with a warranty in accordance with the conditions specified in the warranty card. The buyer loses the right to a warranty repair if the device is not used in accordance with the instructions in the user manual or if it is damaged due to the user's fault.

Repairs of centrifuges should be performed in authorized services of MPW MED.INSTRUMENTS. The centrifuge for repairs should be delivered after disinfection with an attached decontamination declaration.

List of authorized services of MPW MED. INSTRUMENTS is available on the manufacturer's website - <https://mpw.pl/en/contact/contact-details>.

| | |
|---|---|
|  | <ul style="list-style-type: none"> ▪ The warranty period for the devices is 24 months (unless stated otherwise in the proof of purchase). ▪ The warranty conditions are included in the warranty card. ▪ The service life of the device is 10 years. ▪ After 24 months from the beginning of the warranty period (date of purchase), the technical condition of the centrifuge should be inspected (validated) by the manufacturer's authorized service. Subsequent inspections should be carried out at annual intervals. ▪ The permissible period of storage of an unused centrifuge is 1 year. After this period, it should be inspected by an authorized service center. ▪ The producent reserves the right to make changes to the manufactured products. |
|---|---|

12. Transport, storage, disposal

12.1 Transport and storage



CAUTION! Due to the high weight of the device, lifting and carrying it may result in back injury. Use the appropriate number of people to lift and carry. Be assisted by a transport device.

- Only store the device in a closed and dry room.
- Remove the rotor from the centrifuge before transport.
- **Secure the rotor shaft using original transport locks according to the following instructions.**

1

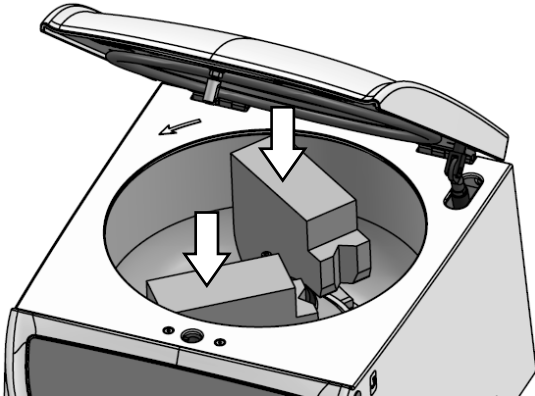

2

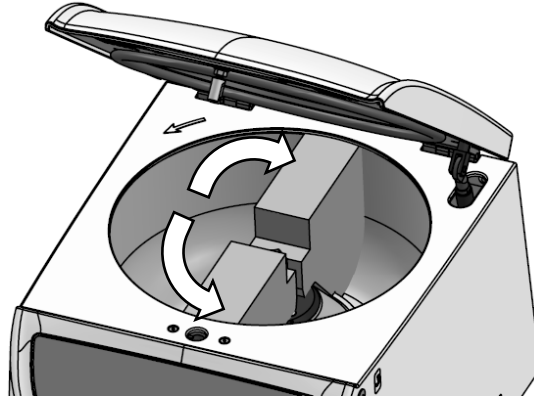

3

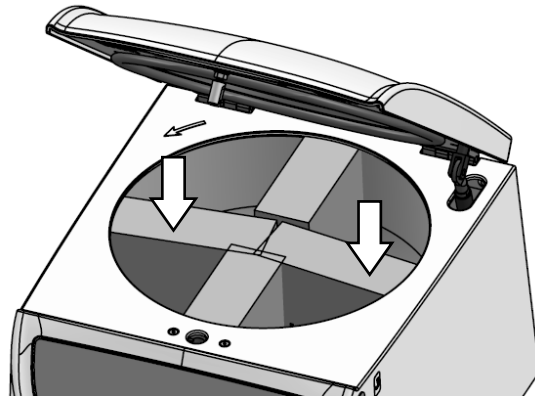

4

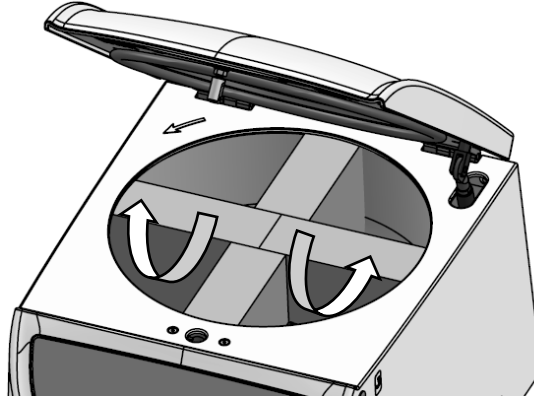



- Use original packaging for transporting the centrifuge and accessories.

12.2 Transport and storage conditions

| | Storage (In the package) | Storage (Without the package) | Transport |
|-------------------|-----------------------------|-------------------------------------|--|
| Temperature | -25 ÷ +55 °C | -5 ÷ +45 °C | -25 ÷ +60 °C (general) -20 ÷ +55 °C (air) |
| Relative humidity | 10 ÷ 75 % | 10 ÷ 75 % | 10 ÷ 75 % |
| Pressure | 70 ÷ 106 kPa | 70 ÷ 106 kPa | 30 ÷ 106 kPa |

12.3 Disposal

| | |
|--|---|
|   | <ul style="list-style-type: none">▪ Dispose of the device in accordance with the applicable legal regulations in the country of use.▪ In the countries of the European Community, the disposal of electrical equipment is regulated under the EU Directive 2012/19/EU on waste electrical and electronic equipment (WEEE). According to these regulations, centrifuges may not be collected together with municipal or household waste.▪ Disposal regulations in individual EU countries may differ. In case of doubt, please contact the supplier of the device. |
|--|---|

13. Manufacturer's information

"MPW MED. INSTRUMENTS" SPÓŁDZIELNIA PRACY

Boremlowska 46 Street

04-347 Warsaw

tel. (+48) 22 610 56 67 (sales department - POLAND)
 (+48) 22 879 70 46 (sales department - outside POLAND)
 (+48) 22 610 81 07 (service)

fax: (+48) 22 610 55 36

e-mail: mpw@mpw.pl

website: www.mpw.pl

000042924 - entry number in the Waste Database Register

PL/CA01-01782 - identification number given by Office for Registration of Medicinal Products, Medical Devices and Biocidal Products.

Distributor's information

DISTRIBUTOR:

14. Annexes

A. Wyposażenie dodatkowe/Optional accessories

MPW M-BASIC

WIRNIK / ROTOR

PARAMETRY WIRNIKA / ROTOR PARAMETERS (RCF [x g], Rmax [mm], α [°])

POJEMNIK/BUCKET

WKŁADKA / ADAPTER

[liczba próbek na wirnik/tubes per rotor] PROBÓWKA / TUBE

12815

RPM 4000 RCF 2003 Rmax 112 α 45/90

13815

14815 Rmax 112 RCF 2003

[8] * Sarstedt S-Monovette® (15 x 75 mm), (4; 4,3; 5,5 ml)

[8] * 10 ml Thermo Nalgene® Oak Ridge (16 x 81,5 mm)

[8] 15121 10 ml probówka z dnem okrągłym i pokrywką (17 x 70 mm)
10 ml tube, round bottom, with cap (17 x 70 mm)

14082+14815 Rmax 112 RCF 2003

[8] * BD Vacutainer® (13 x 75 mm), (1,6-5,3 ml)

[8] * Greiner Vacuette® (13 x 75 mm), (1-4,5 ml)

[8] * Sarstedt S-Monovette® (11 x 66 mm), (1,6; 2; 2,7; 3; 3,1 ml)

[8] * Sarstedt S-Monovette® (13 x 65 mm), (2,6; 2,9; 3,4; 3,8 ml)

[8] * Sarstedt S-Monovette® (13 x 75 mm), (2,7; 3; 4,3 ml)

[8] 15054 6 ml probówka z pokrywką (11,5 x 92 mm), Sarstedt®
6 ml tube with cap (11,5 x 92 mm), Sarstedt®

[8] 15120 5 ml probówka szklana (12 x 75 mm)
5 ml glass tube (12 x 75 mm)

[8] 15419 5 ml probówka z korkiem (12 x 85 mm), Sarstedt®
5 ml tube with cap (12 x 85 mm), Sarstedt®

[8] * Sarstedt V-Monovette urine tube (13 x 75 mm)

[8] * BD urine tube (13 x 75 mm)

12815

RPM 4000 RCF 2290 Rmax 128 α 45/90

13816 R max 128 RCF 2290 x g

14817+14818 Rmax 128 RCF 2290

[2] * 50 ml probówka z dnem stożkowym z zakrętką (30 x 117 mm), Falcon®; [15052] 50ml (30 x 117mm)
50 ml tube, conical bottom, with cap (30 x 117 mm), Falcon®; [15052] 50ml Sarstedt® (30 x 117 mm)

[2] * 50 ml probówka z dnem stożkowym bez rantu (30 x 115 mm), Greiner®
50 ml tube, conical bottom, without skirt (30 x 115 mm), Greiner®

14820 Rmax 128 RCF 2290

[2] * 15 ml probówka z dnem stożkowym z zakrętką (17 x 120 mm), Falcon®; [15050], 15ml (17 x 120 mm)
15 ml tube, conical bottom, with cap (17 x 120 mm), Falcon®; [15050] 15ml Sarstedt®(17 x 120 mm)

14817 Rmax 128 RCF 2290

[2] * 50 ml probówka z dnem stożkowym z rantem (30 x 115 mm), Greiner®
50 ml tube, conical bottom, skirted (30 x 115 mm), Greiner®

12815

RPM 4000 RCF 2290 Rmax 128 α 90

13816 R max 128 RCF 2290 x g

14817+14816 Rmax 128 RCF 2290

[2] * Dr. PRP

[2] * Xerthra 15ml

[2] * Xerthra 20ml

bez wkładki/without adapter Rmax 128 RCF 2290

[2] * Prolo 30

14816 Rmax 128 RCF 2290

[2] * Xerthra 30/60ml

* probówka niedostępna w ofercie MPW lub dostępny odpowiednik (np:[15050]), patrz kolumna z prawej
tube is not offered by MPW or equivalent is available (e.g. [15050]), see column on the right

A. Wyposażenie dodatkowe/Optional accessories**MPW M-BASIC****12815****RPM 4000 RCF 2469 Rmax 138 \angle 45/90**

13815

14082

| | | |
|-----------------------------|-------|--|
| [8] | * | BD Vacutainer® (13 x 100 mm), (4-7 ml) |
| [8] | * | Greiner Vacuette® (13 x 100 mm), (3,5-6 ml) |
| [8] | * | Sarstedt S-Monovette® (11 x 92 mm), (4,5; 5 ml) |
| [8] | * | Sarstedt S-Monovette® (13 x 90 mm), (4,9; 5,6 ml) |
| [8] | 15119 | 7 ml probówka szklana (12 x 100 mm) 7 ml glass tube (12 x 100 mm) |
| [8] | * | BD Vacutainer® CPT™ (13 x 100 mm), (4 ml) |
| [8] | * | Sarstedt V-Monovette urine tube (round base) (13 x 100 mm) |
| bez wkładki/without adapter | | |
| [8] | * | BD Vacutainer® (16 x 100 mm), (2,5-11 ml) |
| [8] | * | Greiner Vacuette® (16 x 100 mm), (7-9 ml) |
| [8] | * | Sarstedt S-Monovette® (15 x 92 mm), (7,5; 8,2; 8,5 ml) |
| [8] | * | Sarstedt S-Monovette® (16 x 92 mm), (9; 10 ml) |
| [8] | 15046 | 14 ml probówka z pokrywką (16,8 x 113,7 mm), Sarstedt® 14 ml tube with cap (16,8 x 113,7 mm), Sarstedt® |
| [8] | 15048 | 15 ml Thermo Nalgene® (16 x 113 mm) 15 ml Thermo Nalgene® (16 x 113 mm) |
| [8] | 15053 | 10 ml probówka z pokrywką (16 x 106 mm) 10 ml tube with cap (16 x 106 mm) |
| [8] | 15118 | 10 ml probówka szklana (16 x 100 mm) 10 ml glass tube (16 x 100 mm) |
| [8] | * | 15 ml probówka z dnem stożkowym z zakrętką (17 x 120 mm), Falcon®; [15050], 15ml (17 x 120 mm) 15 ml tube, conical bottom, with cap (17 x 120 mm), Falcon®; [15050] 15ml Sarstedt®(17 x 120 mm) |
| [8] | * | BD Vacutainer® CPT™ (16 x 125 mm), (8 ml) |
| [8] | * | Greiner Vacuette® Urine culture (16 x 100 mm), (9,5 ml) |
| [8] | * | Sarstedt V-Monovette urine tube (round base) (15 x 100 mm) |
| [8] | * | Sarstedt V-Monovette urine tube (conical base) (15 x 100 mm) |
| [8] | * | BD urine tube (16 x 100 mm) |
| [8] | * | Medlab 35-1205-0P (16x105), (12ml) |
| [8] | * | Medlab 35-1210-0 (16x105), (10ml) |
| [8] | * | Medlab 35-1210-0P (16x105), (12ml) |
| [8] | * | TPP conical tube (17 x 120 mm), (15 ml) |
| [8] | * | TPP round bottoml, tissue culture tube (16 x 120 mm), (5-8 ml) |
| [8] | * | Mini Parasep®SF |

Suma końcowa

EU DECLARATION OF CONFORMITY

This EU declaration of conformity is issued under the sole responsibility of the manufacturer.

Manufacturer: **"MPW MED. INSTRUMENTS" SPÓŁDZIELNIA PRACY**
46 Boremlowska Street, 04-347 Warsaw, Poland

We apply the certified
Quality Management System
in accordance
with the standards: PN-EN ISO 9001:2015, PN-EN ISO 13485:2016

Product name: **Laboratory centrifuge MPW M-BASIC**

The aforementioned product is in conformity with the following EU regulations and directives:

- **2017/746 (IVDR)** REGULATION (EU) 2017/746 OF THE EUROPEAN PARLIAMENT AND OF THE COUNCIL of 5 April 2017 on in vitro diagnostic medical devices and repealing Directive 98/79/EC and Commission Decision 2010/227/EU
- **2011/65/UE (RoHS 2)** DIRECTIVE 2011/65/EU OF THE EUROPEAN PARLIAMENT AND OF THE COUNCIL of 8 June 2011 on the restriction of the use of certain hazardous substances in electrical and electronic equipment

Intended purpose: The product is a benchtop laboratory centrifuge specifically intended by the manufacturer for in vitro diagnostic (IVD) procedures. It is used for the separation of mixtures, suspensions, body fluids into components of different density under the influence of centrifugal force.

Risk class: **Class A (in accordance with Annex VIII, rule 5)**

The assessment of the conformity of the device has been carried out in accordance with Article 48(10) of Regulation (EU) 2017/746.

Wojciech Anisiewicz
Vice-President of the Management Board

Łukasz Sałański
President of the Management Board

DECLARATION OF DECONTAMINATION

(repair)

In order to protect our employees please fill out the declaration of decontamination completely before sending centrifuge to the manufacturer (repair).

1. Device:

– type:

– serial No.:

2. Description of decontamination

(see user manual)

.....

.....

.....

.....

3. Decontamination carried out by:

name:

4. Date and signature:

.....

DECLARATION OF DECONTAMINATION

(return)

In order to protect our employees please fill out the declaration of decontamination completely before sending centrifuge to the manufacturer (return).

1. Device:

– type:

– serial No.:

2. Description of decontamination

(see user manual)

.....
.....
.....
.....

3. Decontamination carried out by:

name:

4. Date and signature:

.....

NOMOGRAM

Centrifuging radius [cm]

R.C.F. (x "g")
multiple of
gravitational
acceleration

[r.p.m.]

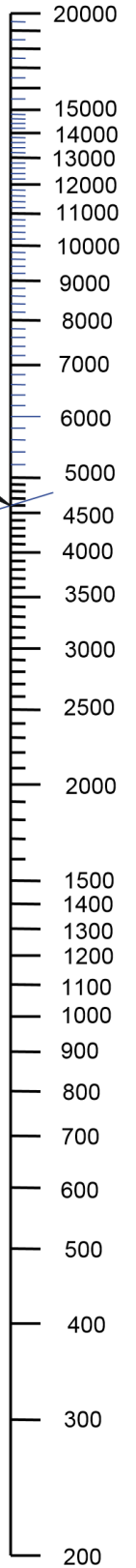
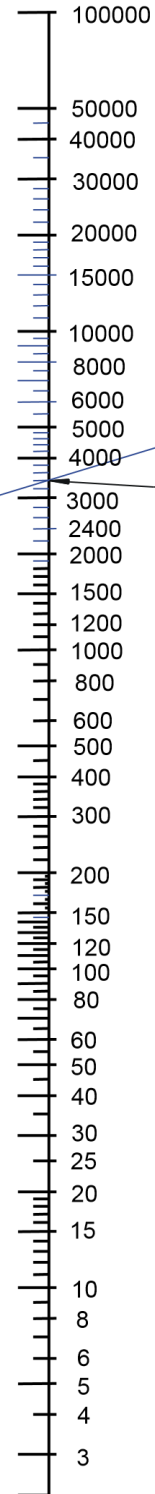
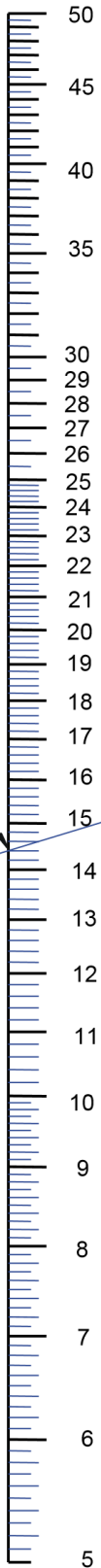

Formula used for calculation of this nomogram :

$$R.C.F. = 11,18 * r * (n/1000)^2$$

where :

- R.C.F. - multiple of gravitational acceleration
- r - centrifuging radius (cm)
- n - rotational speed (r.p.m.)
- g - gravitational acceleration

A

B

C

Example of making use
of the nomogram:

- A=14,4 cm
- B=4600 r.p.m.
- C=3400 x g

$$n = 1000 * \sqrt{\frac{RCF}{(11,18 * r)}}$$

$$r = \frac{RCF}{\left[11,18 * \left(\frac{n}{1000} \right)^2 \right]}$$